

WE PROVIDE SEPARATE MOBILE SPACES, REPLACING STRESS WITH HARMONY & PEACE.

Modern workplaces are adapting to the needs of the people who perform their jobs in them. More and more employees express the desire to find acoustic solutions which would let them work in peace and be more effective.

Providing special zones for phone calls and videoconferences has become one of the crucial elements of an office that is friendly and open to the needs of employees. The best solutions should be flexible and inexpensive to implement, and this is exactly what we provide.

ACOUSTIC PHONE BOOTH IS A PERFECT PLACE FOR:



PRIVATE
VIDEOCONFERENCES



TRADE
NEGOTIATIONS



CONFIDENTIAL TELEPHONE
CONVERSATIONS

WHY IS THE ACOUSTIC PHONE A UNIQUE OFFICE SOLUTION?



COMPACT

Acoustic Phone occupies only 1 square meter – the small dimensions and weight allow it to be set or adjusted to the current needs of any organisation.



FUNCTIONAL

Equipped with lighting, a ventilation system, a folding laptop table, and 230V & USB sockets.



COMFORTABLE TO USE

Thanks to the armrest, a movement sensor which activates the lighting and ventilation, and a rear wall made of glass, the Acoustic Phone provides an excellent user experience.







AGILE

Acoustic Phone is equipped with castors which allows you to move it around the office whenever you need.

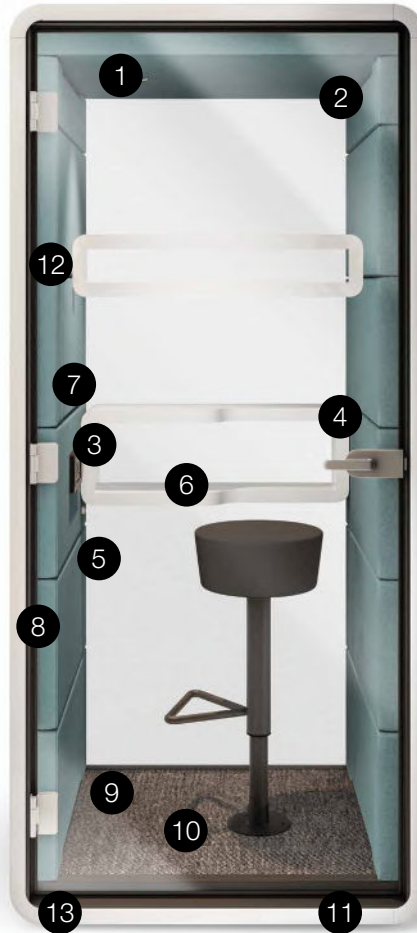
TECHNICAL FEATURES

- 1 Led ceiling light run by motion sensor
- 2 Efficient ventilation run by motion sensor
- 3 Power module (single power, double USB)
- 4 Tempered acoustic glass door with handle
- 5 Glazed acoustic glass rear wall
- 6 Ergonomic shelf / storage
- 7 Fold-away oak veneer laptop table
- 8 Acoustic lined fabric panels
- 9 Integral carpeted floor
- 10 Optional floor mounted stool
- 11 Leveling feet
- 12 Anti-collision door manifestation
- 13 Castors



- +  compact height of 2230 mm
-  excellent sound absorption
-  strong frame construction

Dimensions (mm)

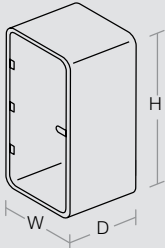

W: 1000 D: 900 H: 2230



COLOUR FINISHES

CARCASS

INTERIOR FABRIC



Haiti



Petrus

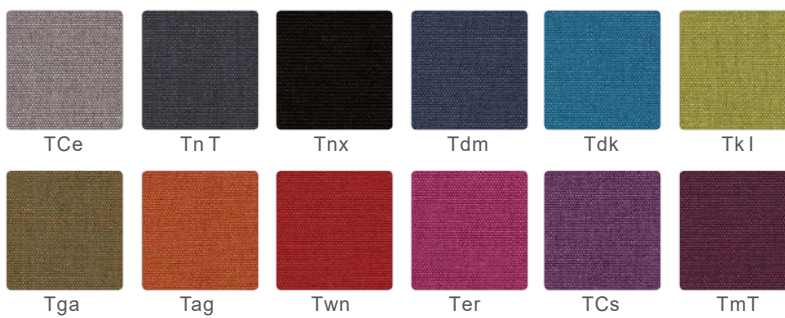

Wool

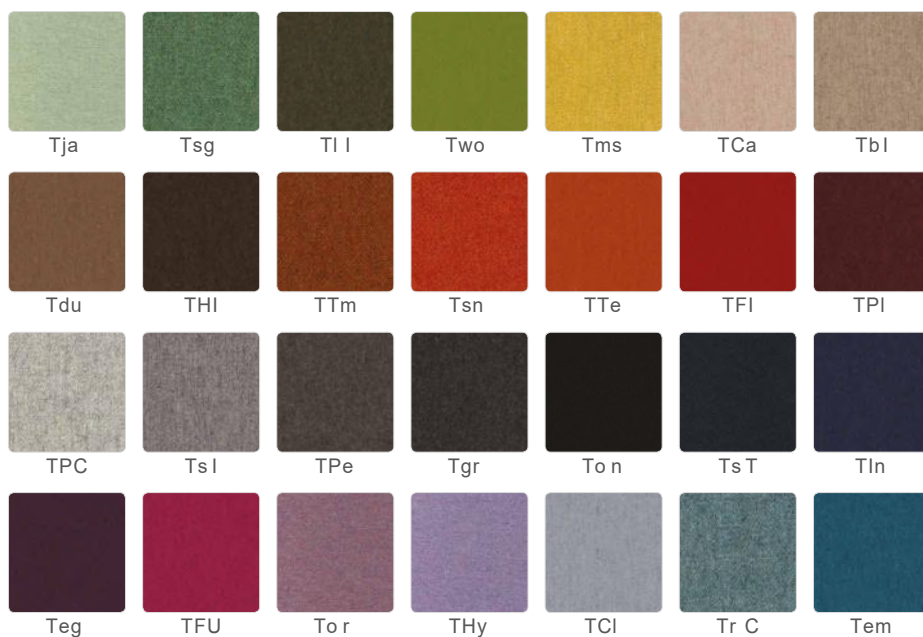

SHELF

