



49.400



Warranty



Addit ErgoDoc document holder - adjustable 400

A very effective, in-line A3 document holder. This ErgoDoc is height adjustable in six small steps. Simply lift it up to slide a keyboard underneath when not in use.

- Suitable for documents/books/folders/dossiers etc. up to A3 size
- Aligns documents and monitor in a straight line, preventing eye fatigue and neck strain
- Saves desk space
- Dimensions (w x d x h): 536 x 270 x 136 - 206 mm (21,1 x 10,6 x 5,4 - 8,1")
- Height adjustable from 136 - 206 mm (5,4" - 8,1") in 6 steps
- 5 mm (0,2") thick clear acrylic
- Max. weight capacity of 6 kg (13 lb)
- Lift up the ErgoDoc for keyboard storage space

addit

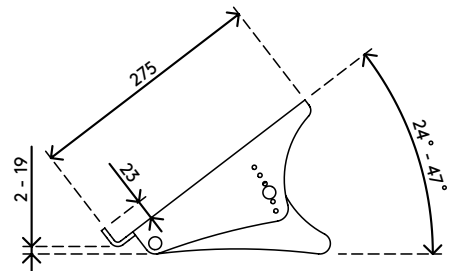
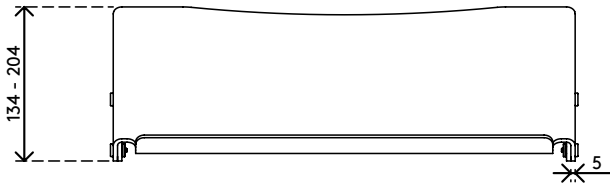
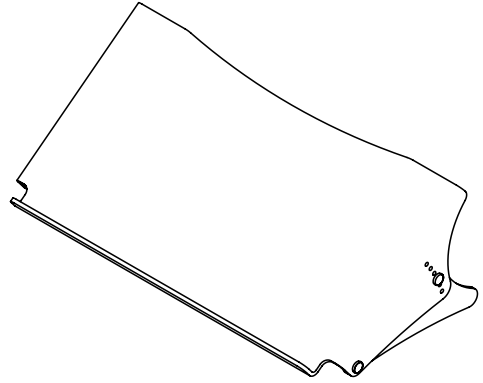
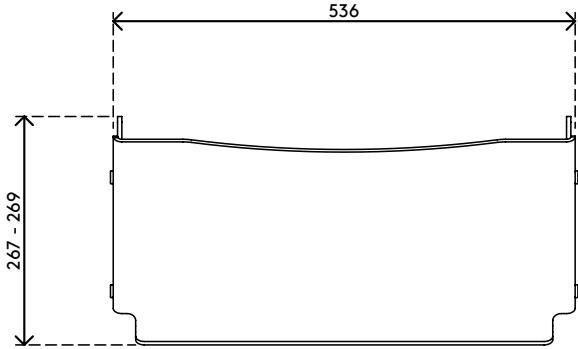

Addit ErgoDoc document holder - adjustable 400

49.400

 580 x 295 x 115 mm

 1 pcs

 clear acrylic

 1,65 kg

 805410494001

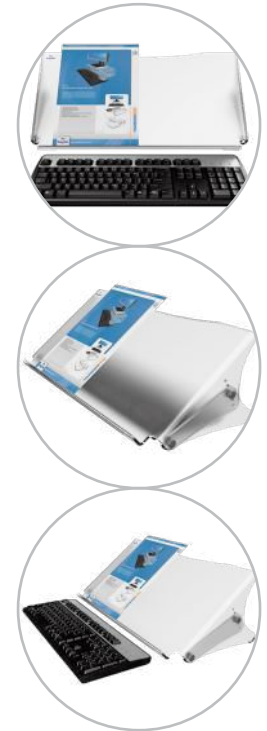

49.401

Addit ErgoDoc document holder - adjustable 401

A very effective, in-line A3 document holder. This ErgoDoc is height adjustable in six small steps. Simply lift it up to slide a keyboard underneath when not in use.



Warranty



years

- Suitable for documents/books/folders/dossiers etc. up to A3 size
- Aligns documents and monitor in a straight line, preventing eye fatigue and neck strain
- Saves desk space
- Dimensions (w x d x h): 536 x 270 x 136 - 206 mm (21,1 x 10,6 x 5,4 - 8,1")
- Height adjustable from 136 - 206 mm (5,4" - 8,1") in 6 steps
- Anti-reflective, 5 mm (0,2") thick matt acrylic
- Max. weight capacity of 6 kg (13 lb)
- Lift up the ErgoDoc for keyboard storage space

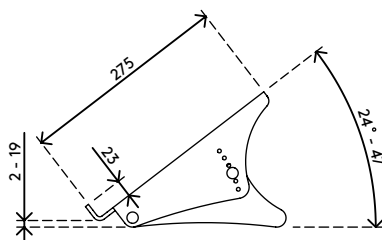
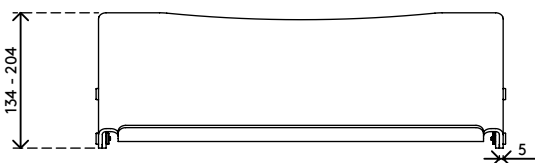
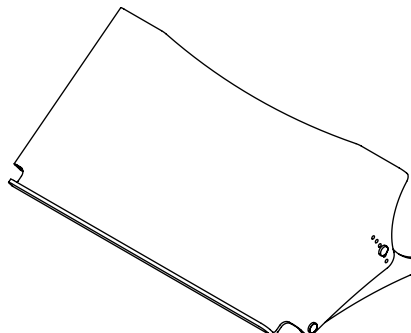
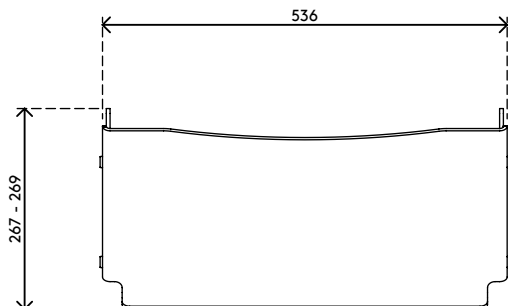

Addit ErgoDoc document holder - adjustable 401

49.401

 580 x 295 x 115 mm

 1 pcs

 matt acrylic

 1,65 kg

 805410494018



Warranty



years



49.411

Addit ErgoDoc document holder - adjustable 411

A very effective, in-line A3 document holder. This ErgoDoc is height adjustable in six small steps. Its raised bottom edge enables its users to simply slide the keyboard underneath when not in use.

- Suitable for documents/books/folders/dossiers etc. up to A3 size
- Aligns documents and monitor in a straight line, preventing eye fatigue and neck strain
- Saves desk space
- Dimensions (w x d x h): 536 x 278 x 160 - 235 mm (21,1 x 10,9 x 6,2 - 9,3")
- Height adjustable from 160 - 235 mm (6,2" - 9,3") in 6 steps
- Anti-reflective, 5 mm (0,2") thick matt acrylic
- Max. weight capacity of 6 kg (13 lb)
- Slide the keyboard underneath the ErgoDoc® for even more desk space

addit

All dimensions are in millimetres (1 mm is 0,039")

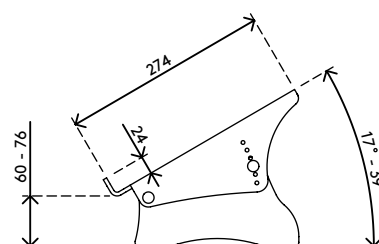
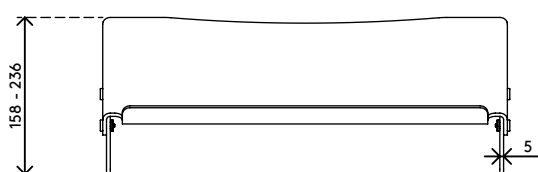
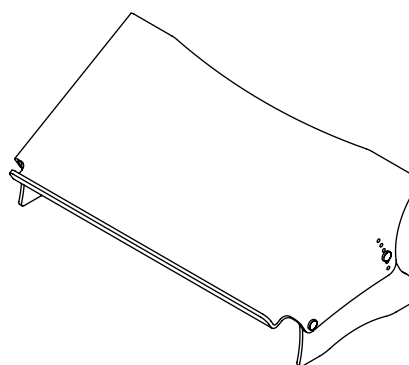
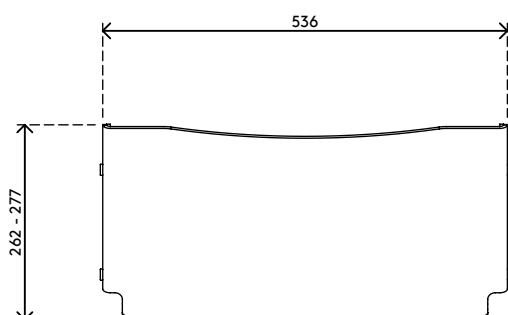

Addit ErgoDoc document holder - adjustable 411

49.411

 590 x 300 x 115 mm

 1 pcs

 matt acrylic

 1,835 kg

 805410494117