

EARL



DYNAMIC & FUNCTIONAL.

Simple and deliberately understated styling is the hallmark of the Earl seating group. The carefully considered upholstered piece can be combined in a multitude of

configurations to create the perfect solution for reception, waiting environments and breakout areas. Earl offers complementary coffee tables to complete any environment.

OPTIONS

Earl is available as a one, two or three seat with a range of coffee tables.



EARL

STANDARD FEATURES (*Selected models only)

- Traditional carcass construction*
- Fitted back cushions
- Fully upholstered
- MFC top*
- Square tubular frame

OPTIONAL FEATURES

- Multi-Fabrics*
- Choice of finish option available - see finish page

MATERIAL CONTENT

Components are constructed of the following

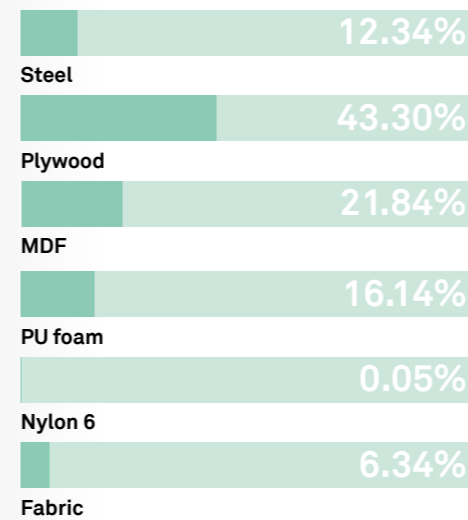

RECYCLED CONTENT

Contains up to 18.9% of Recycled Material

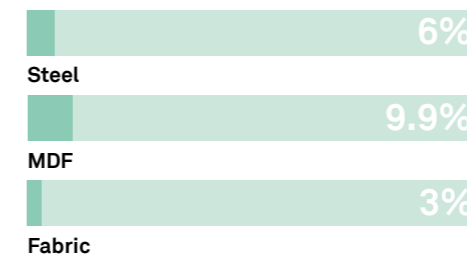

RECYCLABILITY

The range is 99% recyclable

99%

EARL

DIMENSIONS

OH-Overall Height OD-Overall Depth OW-Overall Width AH-Arm Height BH-Back Height SH-Seat Height SW-Seat Width SD-Seat Depth

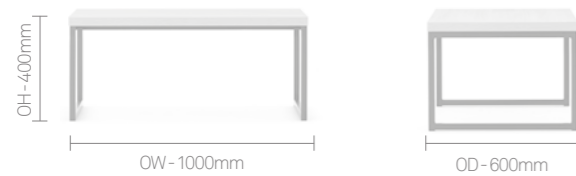
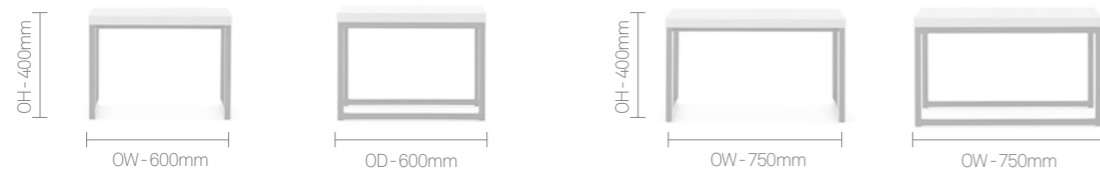
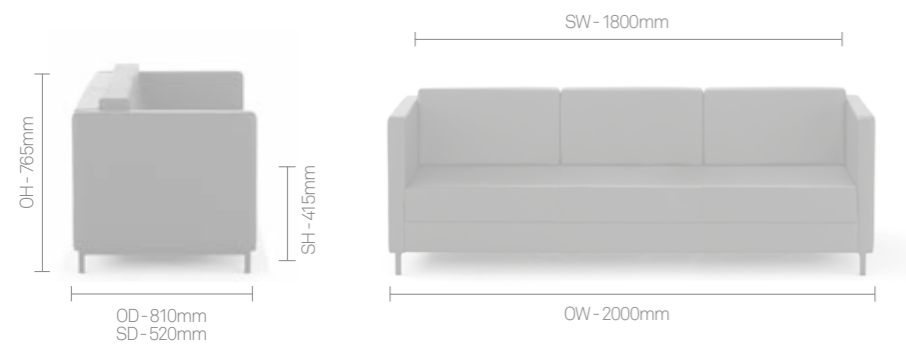
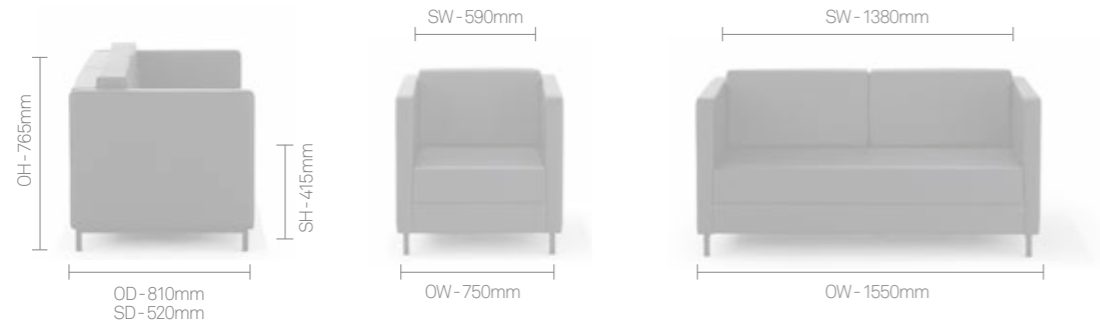

EARL

FINISH OPTIONS

- Square tubular frame available in Black, White or Silver powder coat
- MFC tops are available in Highland Oak, Beech, Autumn & White
- Earl can be upholstered in a broad range of contract upholstery fabrics, leathers and vinyls from the standard upholstery collection

Frame Finishes



Black (Powder Coat)

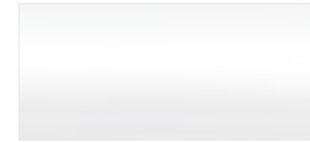

Silver (Powder Coat)

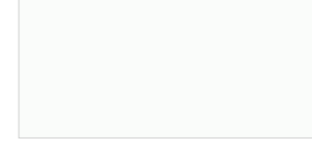

White (Powder Coat)

MFC Finishes



Highland Oak



Beech



Autumn

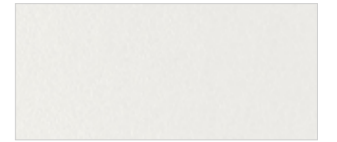

White

Colour images above are for reference only. Please verify with actual colour sample.

EARL

STANDARD & OPTIONAL FEATURES/FINISHES

- Standard feature
- ☐ Not available

	ERL1 One seat chair	ERL2 Two seat sofa	ERL3 Three seat sofa	ERL5 600x600 table	ERL6 750x750 table	ERL7 1000x600 table
Traditional carcass construction	●	●	●	☐	☐	☐
Fitted back cushions	●	●	●	☐	☐	☐
Fully upholstered	●	●	●	☐	☐	☐
25mm MFC tops are available in Highland Oak, Beech, Autumn & White	☐	☐	☐	●	●	●
Square tube frame finished in Black powder coat	●	●	●	●	●	●

Optional features

Square tube frame available in Silver or White powder coat

Multi-Fabrics (use the price band of the highest fabrics selected)

AT A GLANCE

1. Fully upholstered
2. Multi-Fabrics
3. Traditional carcass construction
4. Extra deep seat cushions for maximum comfort
5. Frames available in Black, White and Silver powder coats



Good to know
Earl coffee tables are available in 4 different MFC finishes to complement any fabric selection

Please note: Features are model dependent, please refer to price list pages when specifying

Earl Glide Options*

- Plastic glides are available as standard

*selected models only



Plastic glides

Fabric Band

ERL1
• One seat chair

ERL2
• Two seat sofa

ERL3
• Three seat sofa

1 1+ 2 3 4 5 6 C.O.M.



Top finish

ERL5
• 600x600mm

ERL6
• 750x750mm

ERL7
• 1000x600mm

MFC



TO SPECIFY YOUR CHAIR...

1. Check the Standard Features and Finishes and select the Model you require
2. Select the Band of fabric you are using, this will give you the basic price per chair
3. Select any Optional Extras or Alternative Finishes you require and add on any extra costs as shown per chair
4. You now have the total cost and specification for Your Chair

When ordering, please ensure that you send us all this information, so we can correctly fulfil your requirements.