

prism

The ultimate solution for power and data distribution to touch-down desking and conference tables, where ease of access to utilities is paramount.

PRISM is easily installed into new furniture or retro fitted and may be specified with the full range of data, telecom, audio/visual and power sockets. Integral fuses allow compliance to BS6396:2008 where relevant.

PRISM allows total flexibility to meet the demands of any power and data requirement. Easy to use, PRISM allows essential utility connections to be accessed from both sides of the unit without encroaching on the workspace.

The unit can be closed when most connections (including transformer plugs) have been made, to retain a flat work surface.

Finished in silver and black as standard. Other finishes available subject to order quantity.



USPs

- Designed to operate in the closed position with equipment plugged in
- Available with TUF charger
- Available in a number of specialist finishes including chrome, brass & gold
- BS6396 compliant (where applicable)
- Available with sockets from different nationalities



technical

Common Modular Components*

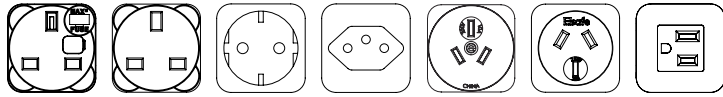

UK fused UK unfused Schuko Swiss Chinese Australian USA/ Japan



French/ Belgian Indian Italian TUF^{5A} Switch Twin data VGA

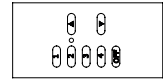

Remote control keypad*

*See website for more

Standard Unit Lengths

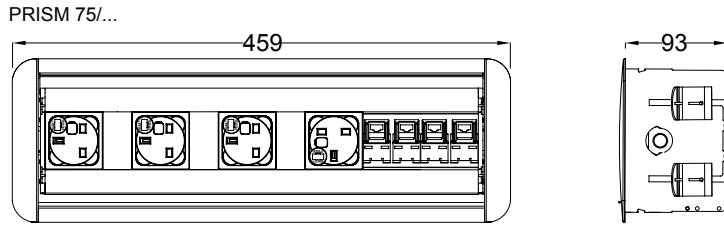
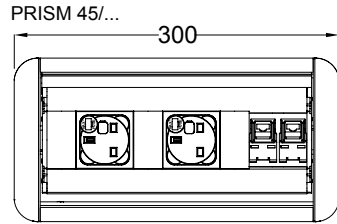
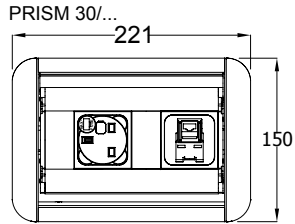

PRISM Installation

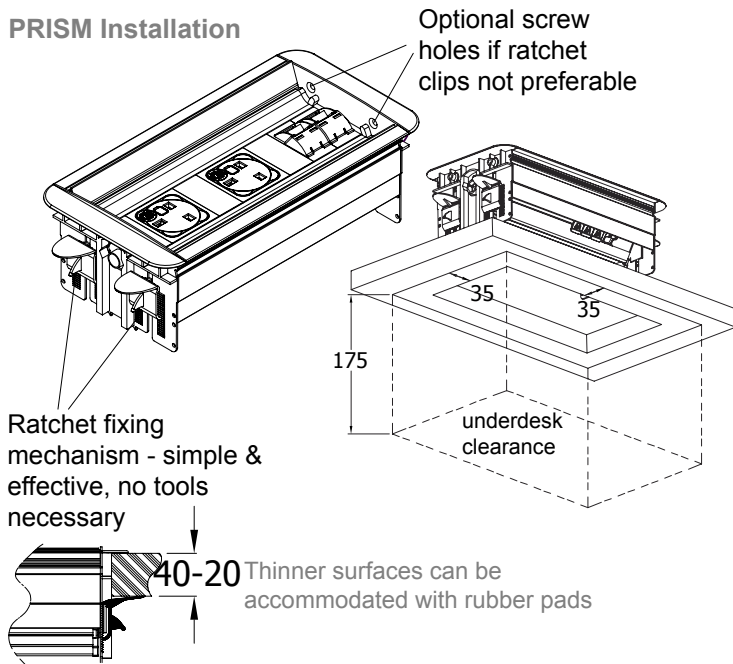

Standard Cutout Sizes

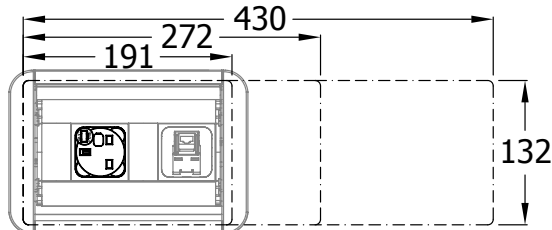

Features

Configuration:

Power only / Data only / Combined (Power & Data/AV)
Internal segregation between Power and Data/AV in combined PRISM units

Earthing: Fully earthed aluminium construction - **both body AND frame** - as required by BS6396

Earth Bonding:

Earth bonding slots along length of the unit allow the attachment of earth bonding lead with standard 3mm ring terminal. Earth bonding kit is sent as standard with every PRISM

Fusing:

(to enable compliance to BS6396)
5 x 20mm anti-surge ceramic fuses, with colour-coded fuseclips to denote the rating (3.15A/5A)

Security:

ANTI-FLEX system: Unique full length locking system guarantees unit integrity regardless of length

Testing:

100% testing - continuity, polarity, insulation & earth

Soft Wiring (power)

Power hardwired to Wieland GST connector allows starter cables to be changed to suit requirements, especially during moves and changes (CHURN)

Soft Wired Data

As well as soft-wired power, PRISM can accommodate soft wired data. Using our inline couplers, data cables can be changed "on-site" to accommodate changes in length often associated with churn

Protection:

Power cleaner, surge protector, MCB, RCD, RCBO, etc.

Conferencing features:

Active Room Control

PRISM can also be fitted with room control keypads which, when used in conjunction with our in-line room controllers, allow the user to control various functions around the room

(eg: blinds, shutters, projection screen and lighting) directly from the PRISM

Follow-me switch

Integration with industry standard VGA switchers to allow intelligent control of AV facilities by multiple delegates

